

WEEKLY TEST TARGET - JEE - TEST - 23
 SOLUTION Date 20-10-2019

[PHYSICS]

1. Potential difference across C and D is 100 V.

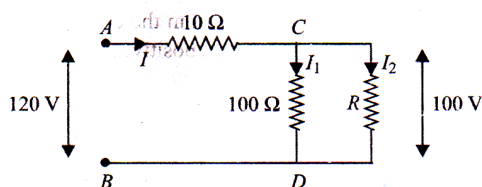

Hence, $I_1 = \frac{100}{100} = 1\text{A}$, $V_{AC} = 120 - 100 = 20\text{V}$

And $I = \frac{20}{10} = 2\text{A}$. Hence, $I_2 = 2 - 1 = 1\text{A}$

$R = 100/I_2 = 100\ \Omega$

2. $\vec{F} = m \frac{\Delta \vec{v}_{cm}}{\Delta t} = \frac{10(3\hat{j} - 4\hat{i})}{2} = 5(3\hat{j} - 4\hat{i})$

$|\vec{F}| = 5\sqrt{3^2 + 4^2} = 25\text{N}$

3. Current through $1\ \Omega$ resistance will be 2 A in the upward direction.

$V_G - 2 \times 4 + 3 - 2 \times 2 + 2 \times 1 = V_H$ or $V_G - V_H = 7\text{V}$

4. Let the speeds of balls of mass m and $2m$ after collision be v_1 and v_2 as shown in the figure. Applying conservation of momentum

$mv_1 + 2mv_2 = mu$ and $-v_1 + v_2 = \frac{u}{2}$

Solving we get $v_1 = 0$ and $v_2 = \frac{u}{2}$

Hence, the ball of mass m comes to rest and ball of mass $2m$ moves with speed.

$t = \frac{2\pi r}{u/2} = \frac{4\pi r}{u}$

5. Evidently, when the block B descends by a distance 'l'. The pulley P, descends by a distance $\frac{l}{2}$, and consequently, the block A ascends by a distance $\frac{l}{2}$. Also, if 'v' be the speed of block A, (up), 2v, would be the speed of block 'B' (down).
 Net loss in P.E. of the system = Loss in P.E of block B. - gain in P.E. of block A

$$mg \frac{l}{2} = \frac{5}{2}mv^2 \Rightarrow v^2 = \frac{gl}{5}$$

$$\text{Total gain in K.E.} = \frac{1}{2}mv^2 + \frac{1}{2}m(2v)^2 = \frac{5}{2}mv^2$$

Now, law of conservation of energy demands
 Loss in P.E. = Gain in K.E.

$$mg \frac{l}{2} = \frac{5}{2}mv^2 \Rightarrow v^2 = \frac{gl}{5}$$

$$v = \sqrt{\frac{gl}{5}}$$

- 6.

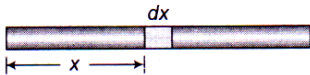

$$x_{cm} = \frac{\int_0^L \frac{K}{L} x^2 dx \cdot x}{\int_0^L \frac{K}{L} x^2 dx} = \frac{\frac{x^4}{4} \Big|_0^L}{\frac{x^3}{3} \Big|_0^L} = \frac{3}{4}L$$

7. The mass move under the influence of gravitational pull which acts along the vertical. Thus CM changes along vertical while it remains unchanged in the horizontal direction.

8. Initial velocity of the particle is $v_i = 20$ m/s
 Final velocity of the particle is $v_f = 0$

From work energy theorem

$$W_{net} = \Delta K.E. = K_f - K_i \\ = \frac{1}{2}m(v_f^2 - v_i^2) = \frac{1}{2}(2)(0 - 400) = -400 \text{ J}$$

9.
 10.
 11.
 12.
 13.

14. [C] Conserving angular momentum about point P

$$\frac{ML^2}{12} \omega = \frac{ML^2}{3} \omega_1; \quad \omega_1 = \frac{\omega}{4}; \quad \therefore v_B = \frac{L\omega}{4}$$

15. [C] $T_1 \frac{3}{2} = T_2 \frac{3}{2} + N \frac{1}{2}$

$$N + T_2 = Mg \\ T_1 + T_2 = N + Mg \\ \frac{T_1}{T_2} = \frac{6}{5}$$

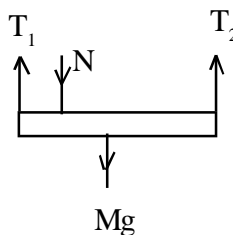

16. . Given $I_2 = I_3$
 $I_2 \times 3R = I_3 R' = I_2 R'$
 So, $R' = 3R$

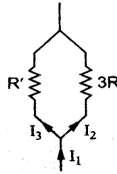

17. The current in CO, OE, DO and OF will be same. So, these branches will not touch each other at O .

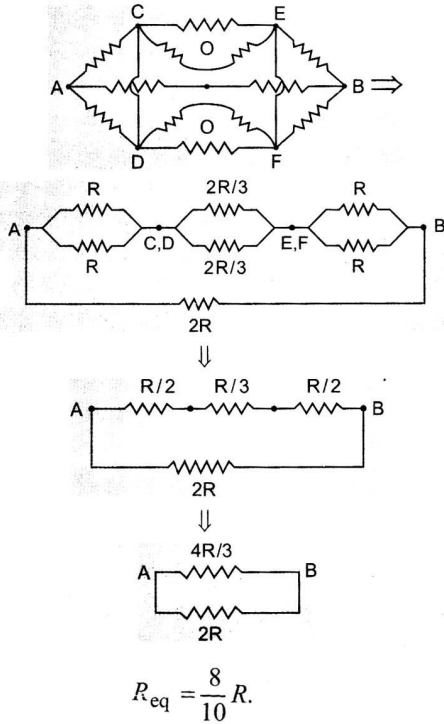

18. No current will pass through C_1 and C_2
 $R_{eq} = 10\Omega$
 $I = 1A$
 $V_A - V_C = 1 \times 6 = 6V$
 $V_C = V_A - 6 = 4V$
 $V_C - V_E = \text{voltage difference across } C_2 = 4V.$

19. It is the speed of light in free space. Hence, dimension is that of speed, i.e., LT^{-1} .

20. Distance travelled in n th second,

$$s_n = u + a \left(n - \frac{1}{2} \right)$$

Distance travelled in 2nd second,

$$s_2 = 0 + a \left(2 - \frac{1}{2} \right) \quad \dots(i)$$

Distance travelled in 5th second,

$$s_5 = 0 + a \left(5 - \frac{1}{2} \right) \quad \dots(ii)$$

Dividing eqn. (ii) by eqn. (i), $s_5 = 24$ m

21.

$$v = \sqrt{v_0^2 + 2gy}$$

and $v \sin \theta = v_0$ (as given in question)

$$\therefore \sin \theta = \frac{v_0}{\sqrt{v_0^2 + 2gy}}$$

$$\therefore \tan \theta = \frac{v_0}{\sqrt{2gy}}$$

$$\frac{dy}{dx} = \frac{v_0}{\sqrt{2gy}}$$

$$\therefore y = \frac{(3gv_0x)^{2/3}}{2g}$$

$$\therefore a + b + c = 8$$

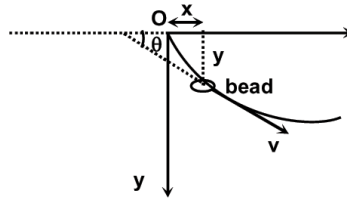

22.

$$\text{Time to cross, } t = \frac{L}{v \cos \theta}$$

$$\therefore ut = d + L \tan \theta = \frac{uL}{v \cos \theta}$$

$$\therefore v = \frac{uL}{d \cos \theta + L \sin \theta}$$

$$\therefore v_{\min} = \frac{uL}{\sqrt{d^2 + L^2}} = 4 \text{ m/s}$$

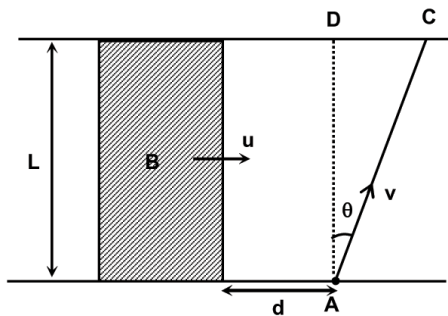

23. If they meet a height h after time T of the projection of the second.

$$\text{Then, } h = u(T) - \frac{1}{2}g(T)^2 = v(T-t) - \frac{1}{2}g(T-t)^2 \quad \dots(i)$$

$$T = \frac{5t^2 + 3t}{10t - 2}$$

$$\text{For minimum } T, \frac{dT}{dt} = 0$$

$$50t^2 - 20t - 6 = 0$$

$$\Rightarrow t = 0.6 = \frac{6}{g}$$

24. For car + trailer system
 $P_{\max} = (3mg \sin \theta + 3kmv^2)v$
 For car only
 $P_{\max} = (mg \sin \theta + 4kmv^2)2v$
 $\therefore (3mg \sin \theta + 3kmv^2)v = (mg \sin \theta + 4kmv^2)2v$
 $\therefore k = \frac{g \sin \theta}{5v^2}$
 For down the incline $kmv_t^2 = mg \sin \theta$
 $\therefore v_t^2 = 5v^2$

25. At the starting (with respect to COM frame)

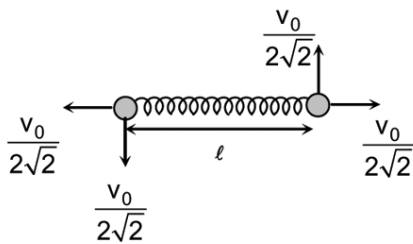

- At the instant of maximum elongation (with respect to the COM frame)

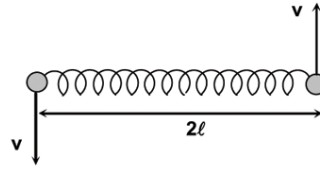

Conservation of angular momentum with respect to centre of mass (COM) frame

$$2m \frac{v_0}{2\sqrt{2}} \frac{l}{2} = 2mv l$$

$$\therefore v = \frac{v_0}{4\sqrt{2}}$$

From conservation of energy with respect to centre of mass frame

$$2 \frac{1}{2} m \left(\frac{v_0^2}{8} + \frac{v_0^2}{8} \right) - 2 \frac{1}{2} m \frac{v_0^2}{32} = U_{\text{spring}}$$

$$\therefore U_{\text{spring}} = mv_0^2 \left(\frac{1}{4} - \frac{1}{32} \right) = \frac{7mv_0^2}{32} = 2 \text{ Joule}$$

[CHEMISTRY]

26. [c] suppose the formula of hydrocarbon is C_xH_y .

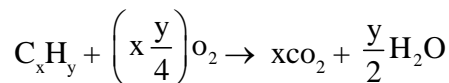

$$1 \text{ vol} \quad x + y/4 \text{ vol.} \quad x \text{ vol} \quad 0 \text{ vol}$$

$$20 \text{ ml} \quad 20 \left(x + \frac{y}{4} \right) \text{ ml} \quad 20 \text{ ml} \quad 0$$

From question vol. of CO_2 formed = 60 ml

$$20x = 60 \therefore x = 3$$

vol of O_2 used = 100 ml

$$20 \left(x + \frac{y}{4} \right) = 100 \therefore y = 8$$

Hence hydrocarbon is C_3H_8

27. [c] neq. of $\text{KMnO}_4 = \text{neq of } \text{H}_2\text{C}_2\text{O}_4$

$$\frac{v \times 0.1 \times 5}{1000} = \frac{40 \times 0.2 \times 2}{1000}$$

$$v = 32 \text{ ml}$$

28. [d] fact

29. [c] fact

30. $6 e^-$ in valence shell of boron

31. $\text{B}_2\text{H}_6 + \text{NH}_3 \xrightarrow[\text{low temperature}]{\text{Excess NH}_3} \text{B}_2\text{H}_6 \cdot 2\text{NH}_3$
or $[\text{H}_2\text{B}(\text{NH}_3)_2]^+ [\text{BH}_4]^-$ (ionic compound).

32. $\text{Cr}_2\text{O}_7^{2-} + 14\text{H}^+ + 6e^- \rightarrow 2\text{Cr}^{3+} + 7\text{H}_2\text{O}$

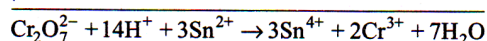
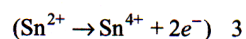

It is clear from this equation that 3 moles of Sn^{2+} reduce one mole of $\text{Cr}_2\text{O}_7^{2-}$, hence 1 mol of Sn^{2+} will reduce $\frac{1}{3}$ moles of $\text{Cr}_2\text{O}_7^{2-}$.

33. (a) $\text{K Cl O}_3 \longrightarrow \text{K Cl} + 3\text{O}_2$
 $\begin{array}{ccccccc} \uparrow & \uparrow & \uparrow & & \uparrow & \uparrow & \uparrow \\ +1 & +5 & -2 & & +1 & -1 & 0 \end{array}$

Cl is reduced and O is oxidised.

(b) $(\text{NH}_4)_2\text{Cr}_2\text{O}_7 \longrightarrow \text{N}_2 + \text{Cr}_2\text{O}_3$
 $\begin{array}{ccccccc} \uparrow & & \uparrow & & \uparrow & & \uparrow \\ -3 & & +6 & & 0 & & +3 \end{array}$

N is oxidised and Cr is reduced.

34. Scattering of light; reason for blue colour for sky.

35. LiHCO_3 is unstable and exists only in solution.

36. LiCl being covalent has the lowest melting point. The melting points of other halides decrease from NaCl to CsCl as the lattice energies decrease.

37. $\text{BaCO}_3 > \text{SrCO}_3 > \text{CaCO}_3 > \text{MgCO}_3$. Thermal stability decreases as the basic character of the metal hydroxide decreases.

38. MgO is basic whereas all other three oxides are amphoteric in nature.

39. $\frac{(r_2)\text{Li}^+}{(r_3)\text{He}^+} = \frac{0.529 \times 2^2 / 3}{0.529 \times 3^2 / 2} = \frac{8}{27}$

40. [b] Fact

41. [b] $\text{CaCl}_2 + \text{NaCl} \rightarrow \begin{array}{c} \text{CaCO}_3 \\ \downarrow \Delta \\ \text{CaO} \end{array}$

$$x \text{ g } (10 - x) \text{ g}$$

$$\therefore \text{ g m eq. of cao} = \text{ g m eq. of CaCl}_2$$

$$\frac{1.62}{56} = \frac{x}{111}$$

$$\therefore \text{mass of CaCl}_2 = 3.21 \text{ g}$$

$$\text{or \% by mass} = 32.1 \%$$

42. [a] each possesses $14 e - 5$ with board order 3.

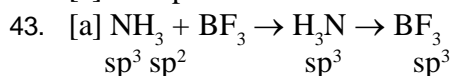

44. [c] O_2^- has one unpaired e

45. (a) Work done = Area enclosed by triangle

$$ABC = \frac{1}{2} AC \times BC = \frac{1}{2} \times (3V - V) \times (3P - P) = 2PV$$

46. $\lambda = \frac{2\pi r_n}{n}$

$$\lambda = \frac{2 \times 3.14 \times 0.529 \times 10^{-10} \times n^2}{n}$$

$$1.67 \times 10^{-9} = 2 \times 3.14 \times 0.529 \times 10^{-10} \times n$$

$$\therefore n = 5$$

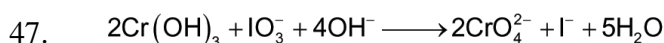

$$x = 2, y = 1, z = 4$$

$$\therefore x + y + z = 2 + 1 + 4 = 7$$

48. $\frac{(t_{1/2})_1}{(t_{1/2})_2} = \left(\frac{P_2}{P_1}\right)^{n-1} \qquad n - 1 = 1$

$$\frac{10}{5} = \left(\frac{200}{100}\right)^{n-1} \qquad n = 2$$

$$2 = 2^{n-1}$$

49. Boron Nitride, Boric acid, Beryllium hydride, Graphite.

50.

$$[\text{CH}_3\text{COOH}] = C_1 = \frac{200 \times 1}{400} = 0.5$$

$$[\text{HCOOH}] = C_2 = \frac{200 \times 0.1}{400} = 0.05$$

$$[\text{H}^+] = \sqrt{K_{a_1} C_1 + K_{a_2} C_2}$$

$$= \sqrt{(10^{-6} \times 0.5) + (10^{-5} \times 0.05)}$$

$$= 10^{-3}$$

$$\text{pH} = -\log 10^{-3} = 3$$

[MATHEMATICS]

51. $y - e^{xy} + x = 0$

Differentiating w.r.t. to y

$$1 - e^{xy} \left(\frac{dx}{dy} \cdot y + x \right) + \frac{dx}{dy} = 0$$

$$\frac{dx}{dy} = 0$$

$$1 - xe^{xy} = 0$$

$$xe^{xy} = 1 \Rightarrow x = 1, y = 0$$

\therefore Point is $(1, 0)$

52. $T_{r+1} = {}^{6561}C_r (7)^{\frac{6561-r}{3}} \left(11^{\frac{1}{9}}\right)^r$

Here r should be a multiple of 9

$$r = 0, 9, 18, \dots, 6561$$

Number of terms = 730

53. Common chord of given circle

$$6x + 4y + (p + q) = 0$$

$$\text{This is diameter of } x^2 + y^2 - 2x + 8y - q = 0$$

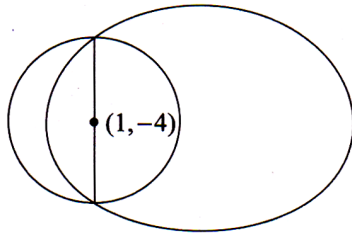
centre $(1, -4)$

$$6 - 16 + (p + q) = 0 \Rightarrow p + q = 10$$

54.
$$\text{Det.}(2A^9 B^{-1}) = \frac{2^2 (\text{Det. } A)^9}{\text{Det. } B} = \frac{2^2 (-1)^9}{2} = -2$$

55. **Hint:** for continuity at $x = 0$

$$\lim_{h \rightarrow 0} f(0+h) = \lim_{h \rightarrow 0} f(0-h) = f(0)$$

$$\lim_{h \rightarrow 0} e^{-h} + a = -3 \Rightarrow a = -4;$$

For the value of a , f is diff at $x = 0$

56.
$$\prod_{r=1}^{99} \begin{bmatrix} 1 & 2r-1 \\ 0 & 1 \end{bmatrix} = \begin{bmatrix} 1 & 1 \\ 0 & 1 \end{bmatrix} \begin{bmatrix} 1 & 3 \\ 0 & 1 \end{bmatrix} \begin{bmatrix} 1 & 5 \\ 0 & 1 \end{bmatrix} \dots \begin{bmatrix} 1 & 99 \\ 0 & 1 \end{bmatrix} = \begin{bmatrix} 1 & 1+3+5+7+\dots+99 \\ 0 & 1 \end{bmatrix} = \begin{bmatrix} 1 & 2500 \\ 0 & 1 \end{bmatrix}$$

$$57. \quad f(x) = \log_x(\ln x)$$

$$\Rightarrow f(x) = \frac{\ln(\ln x)}{\ln x}$$

$$\Rightarrow f'(x) = \frac{\ln x \left(\frac{1}{\ln x} \cdot \frac{1}{x} \right) - \frac{1}{x} \ln(\ln x)}{(\ln x)^2}$$

$$\Rightarrow f'(e) = \frac{1-0}{1} = \frac{1}{e}$$

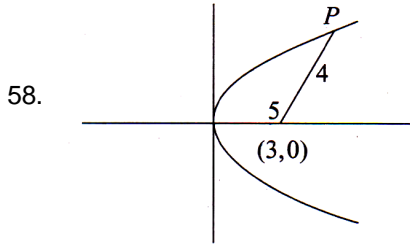

Let the point P be $(3t^2, 6t)$
and $PS = 3 + 3t^2 = 4$

$$t^2 = \frac{1}{3}$$

$$t = \pm \frac{1}{\sqrt{3}}$$

\therefore Points are

$(1, 2\sqrt{3})$ and $(1, -2\sqrt{3})$

$$59. \quad x + \frac{100}{x} > 50$$

$$\left. \begin{array}{l} x = 1 \text{ Satisfies} \\ = 2 \text{ Satisfies} \end{array} \right\} 2 \text{ numbers}$$

$$\text{Ans } P = \frac{55}{100}$$

= 3 does not satisfy

= 47 does not satisfy

$$\left. \begin{array}{l} = 48 \text{ Satisfies} \\ = 100 \text{ Satisfies} \end{array} \right\} 53 \text{ numbers}$$

60. At $(-1, 4)$

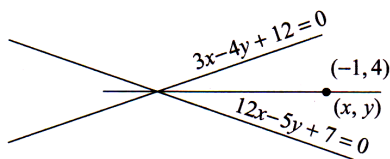

$$3x - 4y + 12 < 0 \quad \text{and} \quad 12x - 5y + 7 < 0$$

$$\Rightarrow \frac{3x - 4y + 12}{12x - 5y + 7} > 0 \quad \text{at } (-1, 4)$$

So we have to take the bisector with + sign

$$\frac{3x-4y+12}{5} = \frac{12x-5y+7}{13}$$

$$21x + 27y - 121 = 0$$

61.

A

Given Expression

$$= \sin^{-1} \cot \left\{ \sin^{-1} \sqrt{\frac{2-\sqrt{3}}{4}} + \cos^{-1} \left(\frac{\sqrt{3}}{2} \right) + \cos \left(\frac{1}{\sqrt{2}} \right) \right\}$$

$$= \sin^{-1} \cot \left\{ \sin^{-1} \sqrt{\frac{2-\sqrt{3}}{4}} + \cos^{-1} \sqrt{\frac{2-\sqrt{3}}{4}} \right\}$$

$$= \sin^{-1} \left\{ \cot \frac{\pi}{2} \right\} = \sin^{-1} 0 = 0$$

62.

B

$$\text{Let } y = \frac{e^{2x} - 1}{e^{2x} + 1}$$

$$\Rightarrow e^{2x} = \frac{-(y+1)}{(y-1)} > 0$$

$$\Rightarrow -1 < y < 1$$

63.

B

$$3 \sin P + 4 \cos Q = 6 \quad \dots\dots\dots(1)$$

$$4 \sin Q + 3 \cos P = 1 \quad \dots\dots\dots(2)$$

From (1) and (2) P is obtuse.

$$(3 \sin P + 4 \cos Q)^2 + (4 \sin Q + 3 \cos P)^2 = 37$$

$$\Rightarrow 9 + 16 + 24 (\sin P \cos Q + \cos P \sin Q) = 37$$

$$\Rightarrow 24 \sin(P+Q) = 12$$

$$\Rightarrow P+Q = \frac{5\pi}{6}$$

$$\Rightarrow R = \frac{\pi}{6}$$

64.

C

Here

$$R = \{(1, 3), (1, 5), (2, 3), (2, 5), (3, 5), (4, 5)\}$$

$$\therefore R^{-1} = \{(3, 1), (5, 1), (3, 2), (5, 2), (5, 3), (5, 4)\}$$

Hence

$$R \circ R^{-1} = \{(3, 3), (3, 5), (5, 3), (5, 5)\}$$

65.

C

We have

$$4 \cot 2\theta = \cot^2 \theta - \tan^2 \theta$$

$$\Rightarrow \frac{4}{\tan 2\theta} = \frac{4}{\tan^2 \theta} - \tan^2 \theta$$

$$\text{Put } \tan 2\theta = \frac{2 \tan \theta}{1 - \tan^2 \theta}$$

$$\therefore \frac{4(1 - \tan^2 \theta)}{2 \tan \theta} = \frac{1 - \tan^4 \theta}{\tan^2 \theta}$$

$$\Rightarrow (1 - \tan^2 \theta)[2 \tan \theta - (1 + \tan^2 \theta)] = 0$$

$$\Rightarrow (1 - \tan^2 \theta)(\tan^2 \theta - 2 \tan \theta + 1) = 0$$

$$\Rightarrow (1 - \tan^2 \theta)(\tan \theta - 1)^2 = 0$$

$$\Rightarrow \tan \theta = 1, -1 \quad \therefore \theta = n\pi \pm \frac{\pi}{4}$$

66.

C

We have

$$|z + \bar{z}| + |z - \bar{z}| = 8$$

$$\Rightarrow 2|x| + 2|y| = 8 \quad \text{or} \quad |x| + |y| = 4$$

67.

BSince $x^2 - 3x + 2$ is one of the factors of the expression $x^4 - px^2 + q$, therefore, on dividing the expression by factor, remainder = 0 i.e., on dividing $x^4 - px^2 + q$ by $x^2 - 3x + 2$, the remainder

$$(15 - 3p)x + (2p + q - 14) = 0$$

On comparing both sides, we get

$$15 - 3p = 0 \quad \text{or} \quad p = 5$$

$$\text{and } 2p + q - 14 = 0 \quad \text{or} \quad q = 4$$

68.

C

$$\det(B^{-1}AB) = \det(B^{-1}) \det A \det B$$

$$= \det(B^{-1}) \times \det B \times \det A = \det(B^{-1}B) \times \det A$$

$$= \det(I) \times \det A = 1 \times \det A = \det A.$$

69.

D

$$\Delta = \begin{vmatrix} a^2 + 2a & 2a + 1 & 1 \\ 2a + 1 & a + 2 & 1 \\ 3 & 3 & 1 \end{vmatrix}$$

$$= \begin{vmatrix} a^2 + 2a - 3 & 2a - 2 & 0 \\ 2a - 2 & a - 1 & 0 \\ 3 & 3 & 1 \end{vmatrix}$$

(Applying $R_1 \rightarrow R_3$, and $R_2 \rightarrow R_2 - R_3$)

$$= \begin{vmatrix} a^2 + 2a - 3 & 2a - 2 \\ 2a - 2 & a - 1 \end{vmatrix}$$

(Expanding along C_3)

$$= (a-1)^2 \begin{vmatrix} a+3 & 2 \\ 2 & 1 \end{vmatrix}$$

$$= (a-1)^2 \cdot (a+3-4) = (a-1)^3$$

Clearly, $\Delta > 0$ if $a > 1$; $\Delta = 0$ if $a = 1$ and $\Delta < 0$ if $a < 1$

70.

B

Given

$$P(A) = 0.5, P(B) = 0.3 \text{ and } P(C) = 0.2$$

$$\therefore P(A) + P(B) + P(C) = 1$$

So the events A, B, C are exhaustive.

If $P(E)$ = Probability of introducing a new product, then as given

$$P(E/A) = 0.7, P(E/B) = 0.6 \text{ and } P(E/C) = 0.5$$

$$\begin{aligned} \therefore P(E) &= P(A) \cdot P\left(\frac{E}{A}\right) + P(B) \cdot P\left(\frac{E}{B}\right) + P(C) \cdot P\left(\frac{E}{C}\right) \\ &= 0.5 \times 0.7 + 0.3 \times 0.6 + 0.2 \times 0.5 \\ &= 0.35 + 0.18 + 0.10 = 0.63 \end{aligned}$$

71.

C

Required limit

$$\begin{aligned}
&= \lim_{x \rightarrow 0} \frac{243^x (3^x - 1) - 9^x (3^{2x} - 1) + (3^x - 1)}{x^3} \\
&= \lim_{x \rightarrow 0} \frac{(3^x - 1) \{(243)^x - (27)^x - 9^x + 1\}}{x^3} \\
&= \lim_{x \rightarrow 0} \frac{(3^x - 1) \{(243)^x - (27)^x - 9^x + 1\}}{x^3} \\
&= \lim_{x \rightarrow 0} \frac{(3^x - 1)(9^x - 1)(27^x - 1)}{x \quad x \quad x} \\
&= \log 3 \cdot \log 9 \cdot \log 27 \\
&= \log 3 \cdot 2 \log 3 \cdot 3 \log 3 \\
&= 6 (\log 3)^3 = k (\log 3)^3
\end{aligned}$$

$$k = 6$$

72. For least area $\lambda = 0$

$$\text{So; } A_{\min} = 2 \int_0^4 (12 - (x^2 - 4)) dx = \frac{256}{3}$$

73. Let $f(x) = \int_0^x \frac{t^8 + 1}{t^8 + t^2 + 1} dt - 3x + 2$

$$f(0) = 2, f(1) = \text{negative}$$

So; $f(x)$ has one root in $[0, 1]$

74.
$$\sin^2 \theta + \operatorname{cosec}^2 \theta = (\sin \theta + \operatorname{cosec} \theta)^2 - 2 \sin \theta \operatorname{cosec} \theta$$

$$= (2)^2 - 2 = 4 - 2 = 2, \text{ since } (\sin \theta + \operatorname{cosec} \theta) = 2.$$

75. Since $\sin 190^\circ = -\sin 10^\circ$, $\sin 200^\circ = -\sin 20^\circ$,
 $\sin 210^\circ = -\sin 30^\circ$, $\sin 360^\circ = \sin 180^\circ = 0$ etc.